

EZLink Par Q6BT ILS

User Manual



Edition Notes

The EZLink Par Q6BT ILS User Manual includes a description, safety precautions, installation, programming, operation, and maintenance instructions for the EZLink Par Q6BT ILS as of the release date of this edition.

Trademarks

Chauvet, Chauvet DJ, the Chauvet logo, and EZLink are registered trademarks or trademarks of Chauvet & Sons, LLC (d/b/a Chauvet and Chauvet Lighting) in the United States and other countries. Other company and product names and logos referred to herein may be trademarks of their respective companies.

Copyright Notice

The works of authorship contained in this manual, including, but not limited to, all designs, text, and images are owned by Chauvet.

© Copyright 2024 Chauvet & Sons, LLC. All rights reserved.

Electronically published by Chauvet in the United States of America.

Manual Use

Chauvet authorizes its customers to download and print this manual for professional information purposes only. Chauvet expressly prohibits the usage, copy, storage, distribution, modification, or printing of this manual or its content for any other purpose without written consent from Chauvet.

Document Printing

For best results, print this document in color, on letter size paper (8.5 x 11 in), double-sided. If using A4 paper (210 x 297 mm), configure the printer to scale the content accordingly.

Intended Audience

Any person installing, operating, and/or maintaining this product should completely read through the guide that shipped with the product, as well as this manual, before installing, operating, or maintaining this product.

Disclaimer

Chauvet believes that the information contained in this manual is accurate in all respects. However, Chauvet assumes no responsibility and specifically disclaims any and all liability to any party for any loss, damage, or disruption caused by any errors or omissions in this document, whether such errors or omissions result from negligence, accident, or any other cause. Chauvet reserves the right to revise the content of this document without any obligation to notify any person or company of such revision; however, Chauvet has no obligation to make, and does not commit to make, any such revisions.

Document Revision

Go to www.chauvetdj.com for the latest version.

Revision	Date	Description
2	02/2024	Updated formatting / added BT cert logo

Table of Contents

1. Before You Begin	1
What Is Included	1
Unpacking Instructions.....	1
Claims	1
Text Conventions	1
Symbols	1
Safety Notes.....	2
FCC Statement of Compliance	2
RF Exposure Warning for North America and Australia.....	3
2. Introduction	4
Product Overview.....	4
Product Dimensions	5
3. Setup	6
AC Power.....	6
Battery Power.....	6
Power Linking.....	7
Mounting	8
Orientation.....	8
Rigging.....	8
4. Operation	9
Control Panel Operation.....	9
Menu Map	9
DMX Configuration.....	9
DMX Personality and Starting Address.....	9
D-Fi USB Connectivity	10
D-Fi USB Compatibility	10
D-Fi USB Configuration.....	10
DMX Values	11
Standalone Configuration.....	11
Preset Color Mode	11
Automatic Programs.....	11
Auto-Program Speed	11
Dimmer.....	11
Sound-Active Programs	11
Sound Sensitivity.....	12
Custom Color Mixing.....	12
IRC-6 Infrared Remote Control	13
IRC-6 Operation	13
Bluetooth Control	13
Master/Slave Mode	14
D-Fi USB Master/Slave Mode	14
ILS Mode.....	14
5. Maintenance.....	15
Product Maintenance	15
6. Technical Specifications	16
Contact Us	17
Warranty & Returns.....	17

1. Before You Begin

What Is Included

- EZLink Par Q6BT ILS
- Power cable
- Quick Reference Guide

Unpacking Instructions

Carefully unpack the product immediately and check the container to make sure all the parts are in the package and are in good condition.

Claims





If the box or the contents (the product and included accessories) appear damaged from shipping, or show signs of mishandling, notify the carrier immediately, not Chauvet. Failure to report damage to the carrier immediately may invalidate a claim. In addition, keep the box and contents for inspection.

For other issues, such as missing components or parts, damage not related to shipping, or concealed damage, file a claim with Chauvet within 7 days of delivery.

Text Conventions

Convention	Meaning
1–512	A range of values
50/60	A set of values of which only one can be chosen
Settings	A menu option not to be modified
<ENTER>	A key to be pressed on the product's control panel
ON	A value to be entered or selected

Symbols

Symbol	Meaning
	Electrical warning. Not following these instructions may cause electrical damage to the product, accessories, or the user.
	Critical installation, configuration, or operation information. Not following these instructions may make the product not work, cause damage to the product, or cause harm to the operator.
	Important installation or configuration information. The product may not function correctly if this information is not used.
	Useful information.

Safety Notes



- **ALWAYS:**
 - ◆ Connect to a grounded circuit.
 - ◆ Connect to operating voltages as specified on the product's spec sticker.
 - ◆ Disconnect from power before replacing the fuse.
 - ◆ Disconnect from its power source during periods of inactivity.
 - ◆ Use a safety cable when suspending overhead.
 - ◆ Heed all restrictions and warnings on the spec sticker.
 - ◆ Mount in a location with at least 20 in (50 cm) of ventilation.
 - ◆ Replace the fuse with the same type and rating.
 - ◆ Use a clamp with a captive bolt when a single hanging bracket is used.
- In the event of a serious operating problem, stop using immediately.
- **DO NOT:**
 - ◆ Open this product or attempt any repairs. It contains no user-serviceable parts.
 - ◆ Look at the light source when the product is on.
 - ◆ Use if the power cord is crimped or damaged.
 - ◆ Disconnect by pulling on the power cord.
 - ◆ Allow flammable materials close to the product when it is operating.
 - ◆ Touch the housing when it is on.
 - ◆ Block any ventilation holes/slots in the housing.
 - ◆ Connect to a dimmer or rheostat.
 - ◆ Carry the product by its power cord.
 - ◆ Operate in temperatures higher than 104°F (40°C).
 - ◆ Expose to environments that exceed the Ingress Protection (IP) rating.
 - ◆ Expose to rain or moisture.
 - ◆ Use outdoors.
 - ◆ Submerge.
 - ◆ Leave outdoors for extended periods of time.
 - ◆ Expose to corrosive environmental conditions such as temperature, humidity, salinity, pressure, radiation, or shock.
 - ◆ Set this product on a flammable surface.



Keep this User Manual for future use. If you sell the product to someone else, be sure that they also receive this document.

FCC Statement of Compliance

This device complies with Part 15 Part B of the FCC rules. Operation is subject to the following two conditions:

1. This device may not cause harmful interference, and
2. This device must accept any interference received, including interference that may cause undesired operation.

This equipment has been tested and found to comply with the limits for a Class B digital device, pursuant to Part 15 of the FCC Rules. These limits are designed to provide reasonable protection against harmful interference in a residential installation. This equipment generates uses and can radiate radio frequency energy and, if not installed and used in accordance with the instructions, may cause harmful interference to radio communications. However, there is no guarantee that interference will not occur in a particular installation. If this equipment does cause harmful interference to radio or television reception, which can be determined by turning the equipment off and on, the user is encouraged to try to correct the interference by one or more of the following measures:

- Reorient or relocate the receiving antenna.
- Increase the separation between the equipment and receiver.
- Connect the equipment into an outlet on a circuit different from that to which the receiver is connected.
- Consult the dealer or an experienced radio/TV technician for help.

Any changes or modifications not expressly approved by the party responsible for compliance could void the user's authority to operate the equipment.

RF Exposure Warning for North America and Australia

Warning! This equipment complies with FCC radiation exposure limits set forth for an uncontrolled environment. This equipment should be installed and operated with a minimum distance of 20 cm between the radiator and the user's body. This transmitter must not be co-located or operating in conjunction with any other antenna or transmitter.

2. Introduction

Product Overview

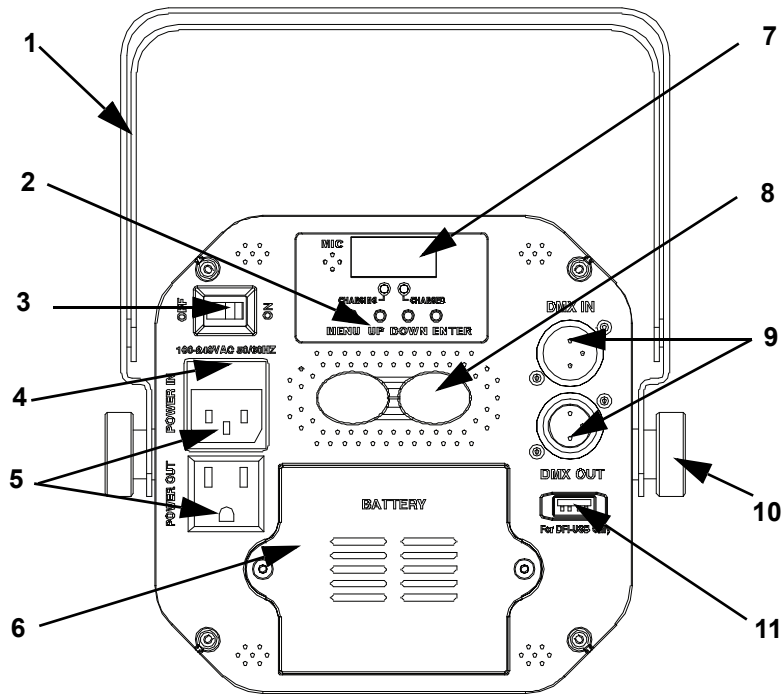

#	Name
1	Mounting bracket
2	Menu buttons
3	Power on/off
4	Fuse holder
5	Power in/out
6	Battery
7	Display screen
8	Safety loop
9	3-pin DMX in/out
10	Bracket adjustment knob
11	D-Fi USB port

Product Dimensions

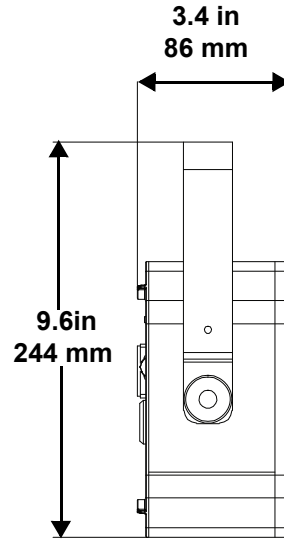
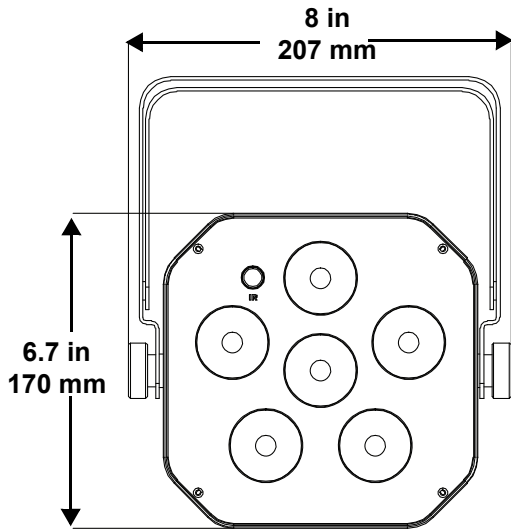

3. Setup

AC Power

The EZLink Par Q6BT ILS has an auto-ranging power supply, and it can work with an input voltage range of 100 to 240 VAC, 50/60 Hz. To determine the product's power requirements (circuit breaker, power outlet, and wiring), use the current value listed on the label affixed to the product's back panel, or refer to the product's specifications chart. The listed current rating indicates the product's average current draw under normal conditions.



- **Always connect the product to a protected circuit (a circuit breaker or fuse). Make sure the product has an appropriate electrical ground to avoid the risk of electrocution or fire.**
- **To eliminate unnecessary wear and improve its lifespan, during periods of non-use completely disconnect the product from power via breaker or by unplugging it.**



Never connect the product to a rheostat (variable resistor) or dimmer circuit, even if the rheostat or dimmer channel serves only as a 0 to 100% switch.

Fuse Replacement

1. Disconnect the product from power.
2. Wedge the tip of a flat-head screwdriver into the slot of the fuse holder.
3. Pry the safety cap out of the housing.
4. Remove the blown fuse from the clip on the front of the safety cap and replace with a fuse of the exact same type and rating.
5. Re-insert the fuse holder and reconnect power.

Battery Power

The EZLink Par Q6BT ILS comes with a rechargeable lithium battery for cable-free operation.

Charging the Battery

The battery charges whenever the EZLink Par Q6BT ILS is plugged into a power source using the included power cord. If the product is plugged in and not in operation, make sure the product is turned off.



- **The LED indicator light will flash if units are overcharged.**
- **DO NOT use the EZLink Par Q6BT ILS on full power mode (all LEDs at 100%) while being charged/plugged into a power source, the unit will get extremely hot.**

Battery Life Indicator

The indicators on the LED Menu Display show how much battery life remains available. The drawing below provides a key to reading the battery life indicators.

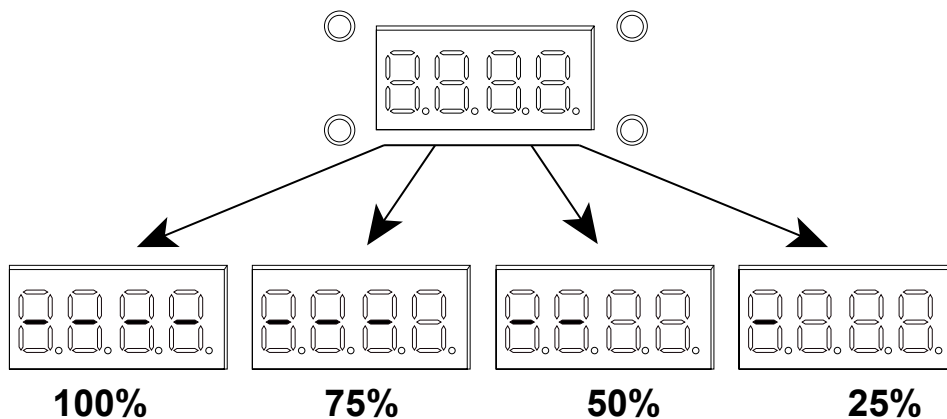

Battery Run Time

Maximum Run Time (all colors on)	Maximum Run Time (single color on)	Recharge Time
Up to 8 hours	Up to 20 hours	4 hours

Power Linking

The product provides power linking via the Edison outlet located in the back of the product. Please see the diagram below for further explanation.

Power-Linking Diagram

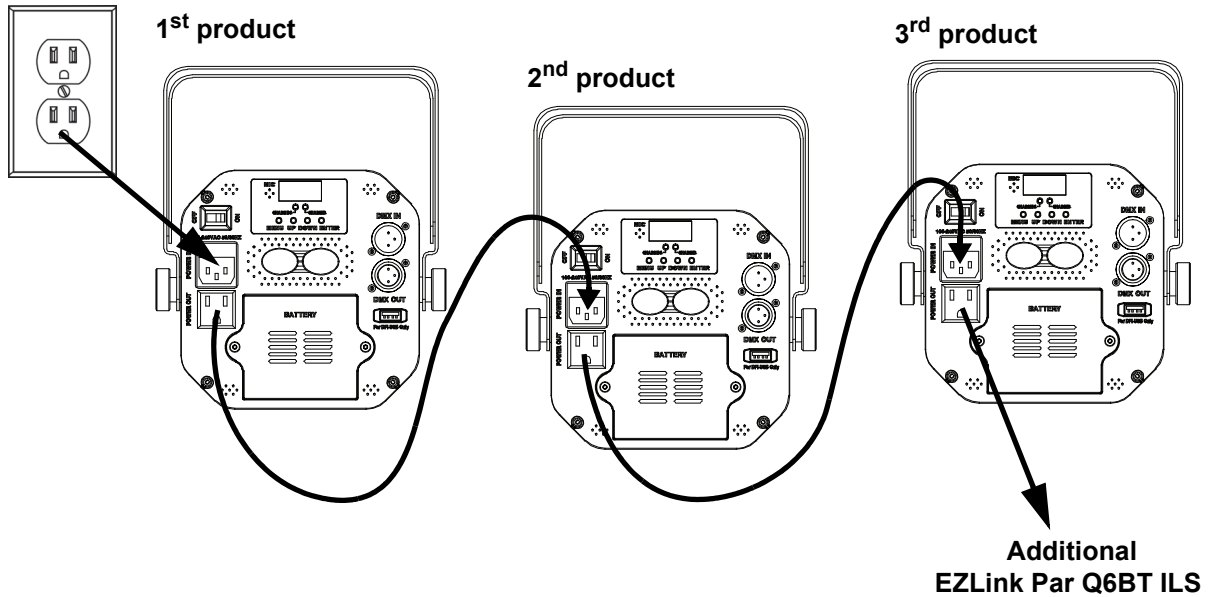

It is possible to power link up to 17 EZLink Par Q6BT ILS products on 120 VAC or up to 31 EZLink Par Q6BT ILS products on 230 VAC.



The power-linking diagram corresponds to the North American version of the product **ONLY!** If using the product in other markets, consult with the local Chauvet distributor, as power-linking connectors and requirements may differ by country or region.

4. Operation

Control Panel Operation

To access the control panel functions, use the four buttons located next to the display. Please refer to the [Product Overview](#) to see the button locations on the control panel.

Button	Function
<MENU>	Exits from the current menu or function
<UP>	Navigates upwards through the menu list and increases the numeric value when in a function
<DOWN>	Navigates downwards through the menu list and decreases the numeric value when in a function
<ENTER>	Enables the currently displayed menu or sets the currently selected value into the selected function

Menu Map

Refer to the EZLink Par Q6BT ILS product page on www.chauvetdj.com for latest menu map/software.

Mode	Programming Levels		Description	
DMX Mode	4Ch	d 1–509	4-channel DMX mode	
	8Ch		8-channel DMX mode	
ILS Mode	iLS	iLS1–4	Sets ILS mode	
Static Colors	C--	C 1–15	Static colors	
Automatic Programs	P--	P 1–5	Automatic programs	
Auto Speed	S--	S. 1–100	Program speed for P 1–5	
Dimmer	d--	L. 1–255	Dimmer	
Sound-Active Mode	Snd	Snd1–5	Sound-active programs	
Sensitivity	SEnS	u 0–100	Sound sensitivity	
Custom Color Mixing	u--	r. 0–255	Custom static colors combine red, green, blue, and amber	
		G. 0–255		
		b. 0–255		
		A. 0–255		
		S. 0–100	Strobe rate	
Bluetooth Mode*	bLE	-----	Bluetooth control mode, displays Bluetooth ID	
Control Mode	SEt	ir	on	Turns infrared on or off
			oFF	
		out	SLAV	Enable Master/Slave with other BT products
			dMX	Enable Master/Slave with non-BT products

*The **Bluetooth**® word mark and logos are registered trademarks owned by the Bluetooth SIG, Inc. and any use of such marks by Chauvet & Sons, LLC is under license. Other trademarks and trade names are those of their respective owners.

DMX Configuration

The EZLink Par Q6BT ILS works with a DMX controller. Information about DMX is in the Chauvet DMX Primer, which is available from the Chauvet website: www.chauvetdj.com.

DMX Personality and Starting Address

When selecting a starting DMX address, always consider the number of DMX channels the selected DMX mode uses. Choosing a starting address that is too high could restrict the access to some of the product's channels.

The EZLink Par Q6BT ILS uses up to 8 DMX channels in a 8Ch DMX mode, which defines the highest configurable address to **505**.

For more information about the DMX protocol, download the DMX Primer from: www.chauvetdj.com.

To select the starting address, do the following:

1. Press <MENU> repeatedly until **4Ch** or **8Ch** shows on the display.
2. Press <ENTER> and **d 1–501** will show on the display.
3. Use <UP> or <DOWN> to select the starting address.
4. Press <ENTER>.

D-Fi USB Connectivity

The EZLink Par Q6BT ILS is able to become a D-Fi wireless receiver/transmitter with the use of the D-Fi USB from Chauvet DJ. Simply set the product's DMX Personality and DMX Address, set the DIP switch D-Fi receiving/transmitting channel, then plug it into the D-Fi USB port.



WARNING! DO NOT plug anything other than a D-Fi USB into the USB port. Doing so may cause damage to the product.



Once plugged in, the D-Fi USB will take over the product. Wired DMX and manual display control / menu buttons will be unavailable until the D-Fi USB is unplugged. The priority levels are:

1. D-Fi USB
2. Wired DMX
3. Manual Digital Display/Menu Buttons

D-Fi USB Compatibility

The D-Fi USB can receive a DMX signal from the D-Fi Hub and the FlareCON Air 2 as well as other D-Fi USB products.

D-Fi USB Configuration

1. Set the DMX Personality and DMX address on the EZLink Par Q6BT ILS .
2. Use the Chart provided to set **BOTH**:
 - the Channel, and
 - the Receiving or Transmitting option



DIP Switch 5 is for Transmitting OR Receiving, please choose carefully.

D-Fi USB DIP Switch Channels

Receiving					Receiving					Transmitting					Transmitting								
Ch.	1	2	3	4	T/R	Ch.	1	2	3	4	T/R	Ch.	1	2	3	4	T/R	Ch.	1	2	3	4	T/R
1	█	█	█	█	█	9	█	█	█	█	█	1	█	█	█	█	█	9	█	█	█	█	█
2	█	█	█	█	█	10	█	█	█	█	█	2	█	█	█	█	█	10	█	█	█	█	█
3	█	█	█	█	█	11	█	█	█	█	█	3	█	█	█	█	█	11	█	█	█	█	█
4	█	█	█	█	█	12	█	█	█	█	█	4	█	█	█	█	█	12	█	█	█	█	█
5	█	█	█	█	█	13	█	█	█	█	█	5	█	█	█	█	█	13	█	█	█	█	█
6	█	█	█	█	█	14	█	█	█	█	█	6	█	█	█	█	█	14	█	█	█	█	█
7	█	█	█	█	█	15	█	█	█	█	█	7	█	█	█	█	█	15	█	█	█	█	█
8	█	█	█	█	█	16	█	█	█	█	█	8	█	█	█	█	█	16	█	█	█	█	█

DMX Values

4Ch	8Ch	Function	Value	Percent/Setting
1	1	Red	000 ⇔ 255	0–100%
2	2	Green	000 ⇔ 255	0–100%
3	3	Blue	000 ⇔ 255	0–100%
4	4	Amber	000 ⇔ 255	0–100%
–	5	Strobe	000 ⇔ 015 016 ⇔ 255	No function Strobe, slow to fast
–	6	Auto programs	000 ⇔ 005 006 ⇔ 055 056 ⇔ 106 107 ⇔ 157 158 ⇔ 208 209 ⇔ 255	No function Auto program 1 (programs 2–5) Auto program 2 Auto program 3 Auto program 4 Auto program 5
–	7	Auto speed	000 ⇔ 250 251 ⇔ 255	Program speed, slow to fast Sound-active mode
–	8	Dimmer	000 ⇔ 255	0–100%

Standalone Configuration

Set the product in one of the standalone modes to control without a DMX controller.



Never connect a product that is operating in any standalone mode to a DMX string connected to a DMX controller. Products in standalone mode may transmit DMX signals that could interfere with the DMX signals from the controller.

Preset Color Mode

To run the EZLink Par Q6BT ILS on a static color, follow the instructions below:

1. Press **<MENU>** repeatedly until **C--** shows on the display.
2. Press **<ENTER>**.
3. Use **<UP>** or **<DOWN>** to select a static color, from **C 1–15**.
4. Press **<ENTER>**.

Automatic Programs

To run the EZLink Par Q6BT ILS in automatic mode, follow the instructions below:

1. Press **<MENU>** repeatedly until **P--** shows on the display.
2. Press **<ENTER>**.
3. Use **<UP>** or **<DOWN>** to select an automatic program, from **P 1–5**.
4. Press **<ENTER>**.

Auto-Program Speed

To change the auto-program speed on the EZLink Par Q6BT ILS, do the following:

1. Press **<MENU>** repeatedly until **S--** shows on the display.
2. Use **<UP>** or **<DOWN>** to increase or decrease the program speed, from **S. 1–100**.
3. Press **<ENTER>**. The product will return to the last selected mode.

Dimmer

To set the dimmer curve, follow the instructions below:

1. Press **<MENU>** repeatedly until **d--** shows on the display.
2. Press **<ENTER>**.
3. Use **<UP>** or **<DOWN>** to increase or decrease the dimmer, from **L. 1–255**.
4. Press **<ENTER>**.

Sound-Active Programs

To run the EZLink Par Q6BT ILS with a sound-active program, follow the instructions below.

1. Press **<MENU>** repeatedly until **Snd** shows on the display.
2. Use **<UP>** or **<DOWN>** to set the Sound-Active program, from **Snd1 to Snd5**.
3. Press **<ENTER>**.

Operation

Sound Sensitivity

To set the sound sensitivity on the EZLink Par Q6BT ILS , do the following:

1. Press **<MENU>** repeatedly until **SEnS** shows on the display.
2. Use **<UP>** or **<DOWN>** to increase or decrease the sound sensitivity, from **u 0–100**.
3. Press **<ENTER>**.

Custom Color Mixing

To custom mix a static color, do the following:

1. Press **<MENU>** repeatedly until **u--** shows on the display.
2. Press **<ENTER>** and one of the following will show on display.
 - **r.---** (red)
 - **G.---** (green)
 - **b.---** (blue)
 - **A.---** (amber)
 - **S.---** (Strobe)
3. Press **<ENTER>** to cycle through the color settings.
4. When the desired color shows on the display, use **<UP>** or **<DOWN>** to increase or decrease the color value, from **000–255** (red, green, blue, amber) or **000–100** (Strobe).
5. Repeat steps 3 and 4 until the product outputs as desired.

IRC-6 Infrared Remote Control

The EZLink Par Q6BT ILS can be operated with the Chauvet IRC-6. To enable IR wireless control, follow the instructions below.

1. Press **<MENU>** repeatedly until **SEt** shows on the display.
2. Press **<ENTER>**.
3. Press **<UP>** repeatedly until **ir** shows on the display.
4. Press **<ENTER>**.
5. Press **<UP>** repeatedly until **ON** shows on the display

IRC-6 Operation

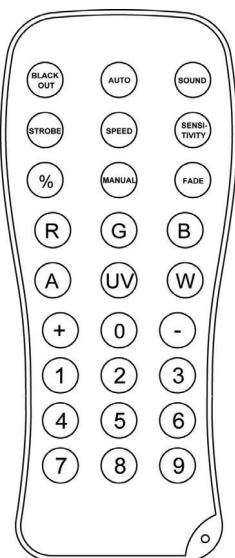

Automatic Mode

To turn on Automatic mode with the IRC-6:

1. Press **<AUTO>** on the IRC-6.
2. Press **<+>** or **<->** to change program.

Sound-Active Mode

To turn on Sound-Active mode with the IRC-6:

1. Press **<SOUND>** on the IRC-6.
2. Press **<+>** or **<->** to increase or decrease the sensitivity.

To adjust the sound sensitivity:

1. Press **<SENSITIVITY>** on the IRC-6.
2. Press **<+>** or **<->** to increase or decrease the sensitivity.

Strobe

To turn on Strobe mode with the IRC-6:

1. Press **<STROBE>** on the IRC-6.
2. Press **<+>** or **<->** to increase or decrease the strobe speed.

Manual Control

To manually select the laser color with the IRC-6:

1. Press the desired color, from **<R>** (red), **<G>** (green), **** (blue), or **<A>** (amber).

To manually select the laser pattern with the IRC-6:

1. Select a manual color.
2. Press **<+>** or **<->** to cycle through the patterns.

Black Out

To black out the lights with the IRC-6:

1. Press **<BLACK OUT>** on the IRC-6.

This will turn off all the lights until the button is pressed again.

NOTE: The IRC-6 will not respond to any inputs when Black Out is activated. If the product does not respond when a button is pressed, try pressing **<BLACK OUT>**. Black Out may have been activated.



- Any setting on the IRC-6 will be saved until the system is rebooted. The system will revert to Auto Mode after reboot.
- The buttons on the IRC-6 not listed above are reserved for future use.

Bluetooth Control

Bluetooth control mode allows users to control one or more EZLink Par Q6BT ILS products via Bluetooth connection on the BTAir app.

To operate the product via Bluetooth control mode:

1. Press **<MENU>** repeatedly until **bLE** shows on the display.
2. Press **<ENTER>**.
3. Use the ID number on the display to identify the product on the BTAir app.



- Ensure that all products are set to Bluetooth control mode prior to operating the BTAir app, as failure to do so may require restarting the app.
- For further instructions on how to pair and operate products with the BTAir app, download the BTAir User Manual from www.chauvetdj.com.

Master/Slave Mode

The Master/Slave mode allows a single EZLink Par Q6BT ILS product (the “master”) to control the actions of one or more EZLink Par Q6BT ILS products (the “slaves”) without the need of a DMX controller. The master product will be set to operate in Standalone, whereas the slave products will be set to operate in Slave mode. Once set and connected, the slave products will operate in unison with the master product. Configure the products as indicated below.

Slave products:

1. Press **<MENU>** repeatedly until **4-CH** shows on the display.
2. Press **<ENTER>**.
3. Set the DMX address to **d 1**.
4. Connect the DMX input of the first slave product to the DMX output of the master product.
5. Connect the DMX input of the subsequent slave products to the DMX output of the previous slave product.
6. Finish setting and connecting all the slave products.

Master product:

1. Press **<MENU>** repeatedly to go to the desired function or program.
2. Press **<ENTER>**.
3. Set the master product to operate in standalone.
4. Make the master product the first product in the DMX daisy chain.



- **Configure all the slave products before connecting the master to the daisy chain.**
- **Never connect a DMX controller to a DMX string configured for Master/Slave operation because the controller may interfere with the signals from the master.**
- **Do not connect more than 18 slaves to the master.**

D-Fi USB Master/Slave Mode

The D-Fi USB allows a single EZLink Par Q6BT ILS product (the “master”) to control the actions of one or more EZLink Par Q6BT ILS products (the “slaves”) without the need of a DMX controller or DMX cables. The master (transmitter) product will be set to operate in standalone mode, while the slave (receiver) products will be set to operate in DMX mode. Once set and connected, the slave products will operate in unison with the master product. Configure the products as indicated below.

Slave products:

1. Press **<MENU>** repeatedly until **4-CH** shows on the display.
2. Press **<ENTER>**.
3. Use **<UP>** or **<DOWN>** to set the starting address to **d 1**.
4. Press **<ENTER>**.
5. Set the D-Fi USB to receive on a specific channel, 1–16.
6. Plug in the D-Fi USB.
7. Finish setting and connecting all the slave products.

Master product:

1. Set the master product to operate in standalone mode.
2. Set the D-Fi USB to transmit on the D-Fi channel the slaves are receiving on.
3. Plug in the D-Fi USB.



- **All products must be set to the same DMX personality, DMX address, and D-Fi channel.**
- **Configure all the slave products before configuring the master to transmit.**
- **Never connect a DMX controller to a D-Fi channel configured for Master/Slave operation because the controller may interfere with the signals from the master.**

ILS Mode

ILS (Integrated Lighting System) provides 4 modes that synchronize with the GigBAR MOVE+ILS: Modes 1 and 3 synchronize with side 1 of the GigBAR MOVE+ILS, whereas modes 2 and 4 synchronize with side 2 of the GigBAR MOVE+ILS. When linked, effects will sync with the most similar effect on the selected side of the GigBAR MOVE+ILS: Kinta effects will sync with one of the kintas, moving heads will sync with one of the moving heads, and wash effects will sync with one of the pars. Laser effects will sync with the laser, and strobe effects will sync with the strobe effects regardless of ILS mode. This product will synchronize with the par effect on the selected side of the GigBAR MOVE+ILS.

To set the EZLink Par Q6BT ILS to respond to an ILS signal:

1. Press **<MENU>** repeatedly until **iLS** shows on the display.
2. Use **<UP>** or **<DOWN>** to select from **iLS1** (side 1), **iLS2** (side 2), **iLS3** (side 1), or **iLS4** (side 2).
3. Press **<ENTER>**.

5. Maintenance

Product Maintenance

Dust build-up reduces light output performance and can cause overheating. This can lead to reduction of the light source's life and/or mechanical wear. To maintain optimum performance and minimize wear, clean the lighting products at least twice a month. However, be aware that usage and environmental conditions could be contributing factors to increase the cleaning frequency.

To clean the product, follow the instructions below:

1. Unplug the product from power.
2. Wait until the product is at room temperature.
3. Use a vacuum (or dry compressed air) and a soft brush to remove dust collected on the external surface/vents.
4. Clean all transparent surfaces with a mild soap solution, ammonia-free glass cleaner, or isopropyl alcohol.
5. Apply the solution directly to a soft, lint-free cotton cloth or a lens-cleaning tissue.
6. Softly drag any dirt or grime to the outside of the transparent surface.
7. Gently polish the transparent surfaces until they are free of haze and lint.



Always dry the transparent surfaces carefully after cleaning them.

6. Technical Specifications

Dimensions and Weight

Length	Width	Height	Weight
8 in (207 mm)	9.6 in (244 mm)	3.4 in (86 mm)	3.8 lb (1.7 kg)

Note: Dimensions in inches rounded to the nearest hundredth.

Power

Power Supply Type	Range	Voltage Selection
Switching (internal)	100 to 240 VAC, 50/60 Hz	Auto-ranging

Parameter	120 V, 60 Hz	230 V, 50 Hz
Consumption	33 W	32 W
Operating current	0.5 A	0.3 A
Power-linking current (products)	8 A (17 products)	8 A (31 products)
Fuse	T 1 A, 250 V	T 1 A, 250 V

Power I/O	U.S./Canada	Worldwide
Power input connector	IEC	IEC
Power output connector	Edison	IEC
Power cord plug	Edison (U.S.)	Local plug

Light Source

Type	Quantity	Color	Power	Current	Lifespan
LED	6	Quad-color RGBA	3 W	1 A	50,000 hours

Photometrics

Strobe Rate	Beam Angle	Field Angle	Illuminance @2m
0 to 25 Hz	16°	30°	1,587 lux

Thermal

Maximum External Temperature	Cooling System
104 °F (40 °C)	Convection

DMX

I/O Connector	Channel Range
3-pin XLR	4 or 8

Ordering

Product Name	Item Code	UPC Number
EZLink Par Q6BT ILS	10032010	781462223588



Contact Us

General Information	Technical Support
Chauvet World Headquarters	
Address: 3360 Davie Rd., Suite 509 Davie, FL 33314 Voice: (954) 577-4455 Fax: (954) 929-5560 Toll Free: (800) 762-1084	Voice: (844) 393-7575 Fax: (954) 756-8015 Email: chauvetcs@chauvetlighting.com Website: www.chauvetdj.com
Chauvet U.K.	
Address: Pod 1 EVO Park Little Oak Drive, Sherwood Park Nottinghamshire, NG15 0EB UK Voice: +44 (0) 1773 511115 Fax: +44 (0) 1773 511110	Email: UKtech@chauvetlighting.eu Website: www.chauvetdj.eu
Chauvet Benelux	
Address: Stokstraat 18 9770 Kruishoutem Belgium Voice: +32 9 388 93 97	Email: BNLtech@chauvetlighting.eu Website: www.chauvetdj.eu
Chauvet France	
Address: 3, Rue Ampère 91380 Chilly-Mazarin France Voice: +33 1 78 85 33 59	Email: FRtech@chauvetlighting.fr Website: www.chauvetdj.eu
Chauvet Germany	
Address: Bruno-Bürgel-Str. 11 28759 Bremen Germany Voice: +49 421 62 60 20	Email: DEtech@chauvetlighting.de Website: www.chauvetdj.eu
Chauvet Mexico	
Address: Av. de las Partidas 34 - 3B (Entrance by Calle 2) Zona Industrial Lerma Lerma, Edo. de México, CP 52000 Voice: +52 (728) 690-2010	Email: servicio@chauvet.com.mx Website: www.chauvetdj.mx

Warranty & Returns

For warranty terms and conditions and return information, please visit our website.

For Customers in the United States and Mexico: www.chauvetlighting.com/warranty-registration. For Customers in the United Kingdom, Republic of Ireland, Belgium, the Netherlands, Luxembourg, France, and Germany: www.chauvetlighting.eu/warranty-registration.